

Instructions for use

KitchenAid

Important safety instructions	4
Safeguarding the environment	6
Before using the appliance	6
Precautions and general recommendations	7
Energy-saving tips	7
Electrical connection for Great Britain and Ireland only	8
Using for the first time	8
Maintenance and cleaning of the appliance	8
Replacing the light bulb or LED (depending on the model)	9
In the event of non-use of the appliance	9
In the event of an interruption to the power supply	9
Refrigerator compartment	9
Freezer compartment	10
How to defrost the freezer compartment (depending on the model)	11
STOP FROST SYSTEM (depending on the model)	11
Procedure to clean the STOP FROST accessory	11
“Zero Degrees” compartment (depending on the model)	12
Use of wooden accessories (if present)	14
Technical Assistance Service	15

Important safety instructions

- **WARNING:** to avoid a hazard due to instability, positioning or fixing of the appliance must be done in accordance with the manufacturer instructions.
 - **WARNING:** keep the appliance ventilation openings clear of obstruction.
 - **WARNING:** do not damage the appliance refrigerant circuit pipes.
 - **WARNING:** Do not use mechanical, electric or chemical means other than those recommended by the Manufacturer to speed up the defrost process.
 - **WARNING:** Do not use or place electrical devices inside the appliance compartments if they are not of the type expressly authorised by the Manufacturer.
 - **WARNING:** (if present) ice-makers and/or water dispensers not directly connected to the water supply must be filled with potable water only.
 - **WARNING:** (if present) automatic ice-makers and/or water dispensers must be connected to a water supply that delivers potable water only, with main water pressure between 0,17 and 0,81 MPa (1,7 and 8,1 bar).
- Information:** This appliance does not contain CFCs.
- Appliances with Isobutane (R600a): isobutane is a natural gas without environmental impact, but is flammable. Therefore, make sure the refrigerant circuit pipes are not damaged. Keep special attention in case of damaged pipes emptying the refrigerant circuit.
 - C-Pentane is used as blowing agent in the insulation foam and it is a flammable gas. Pay special attention during disposal operations.
 - This appliance is intended to be used in household and similar applications such as - staff kitchen areas in shops, offices and other working environments;
 - farm houses and by clients in hotels, motels and other residential type environments;
 - bed and breakfast type environments;
 - catering and similar non-retail applications
 - Do not store explosive substances such as aerosol cans with a flammable propellant in this appliance.
 - This appliance can be used by children aged from 8 years and above and persons with reduced physical, sensory or mental capabilities or lack of experience and knowledge if they have been given supervision or instruction concerning use of the appliance in a safe way and understand the hazards involved.
 - Cleaning and user maintenance

shall not be made by children without supervision.

- To avoid the risk of children becoming trapped and suffocating, do not allow them to play or hide inside the appliance.
- It must be possible to disconnect the appliance from the power supply by unplugging it if plug is accessible, or by means of an accessible multi-pole switch installed upstream of the socket in conformity with national safety standards.
- Plug the appliance into a grounding socket: the appliance must be correctly connected to an approved earthing system.
- Do not use single/multi adapters or extension cords.
- During installation, make sure the appliance does not damage the power cable.
- Do not pull the appliance power cable
- The appliance must be handled and installed by two or more persons.
- Installation and maintenance including replacement of the supply cord must be carried out by the manufacturer or a qualified technician, in compliance with the manufacturer's instructions and the local safety regulations in force. In order to avoid a hazard do not repair or replace any part of

the appliance including the supply cord, unless specifically stated in the user manual.

- This appliance can be used by children aged from 8 years and above and persons with reduce physical, sensory or mental capabilities or lack of experience and knowledge if they have been given supervision or instruction concerning use of the appliance in a safe way and understand the hazards involved.
- Cleaning and user maintenance shall not be made by children without supervision.
- To avoid the risk of children becoming trapped and suffocating, do not allow them to play or hide inside the appliance.
- It must be possible to disconnect the appliance from the power supply by unplugging it if plug is accessible, or by means of an accessible multi-pole switch installed upstream of the socket in conformity with national safety standards.
- Plug the appliance into a grounding socket: the appliance must be correctly connected to an approved earthing system.
- Do not use single/multi adapters or extension cords.
- During installation, make sure the appliance does not damage the power cable.

- Do not pull the appliance power cable
- The appliance must be handled and installed by two or more persons.
- Installation and maintenance including replacement of the supply cord must be carried out by the manufacturer or a qualified

technician, in compliance with the manufacturer’s instructions and the local safety regulations in force. In order to avoid a hazard do not repair or replace any part of the appliance including the supply cord, unless specifically stated in the user manual.

Safeguarding the environment

1. Packing

The packing material is 100% recyclable and bears the recycling symbol . For disposal, comply with the local regulations. Keep the packing materials (plastic bags, polystyrene parts, etc.) out of the reach of children, as they are a potential source of danger.

2. Scrapping/Disposal

The appliance is manufactured using recyclable material.

This appliance is marked in compliance with European Directive 2002/96/EC on Waste Electrical and Electronic Equipment (WEEE). By ensuring the correct disposal of this appliance, you can help prevent potentially negative consequences for the environment and the health of persons.

The symbol  on the appliance, or on the accompanying documents, indicates that this appliance should not be treated as domestic waste but must be taken to a special collection centre for the recycling of electrical and electronic equipment. When scrapping the appliance, make it unusable by cutting off the power cable and removing the doors

and shelves so that children cannot easily climb inside and become trapped.

Scrap the appliance in compliance with local regulations on waste disposal, taking it to a special collection centre; do not leave the appliance unattended even for a few days, since it is a potential source of danger for children.

For further information on the treatment, recovery and recycling of this product, contact your competent local office, the household waste collection service or the shop where you purchased the appliance.

Declaration of conformity

- This appliance has been designed for preserving food and is manufactured in compliance with Regulation (CE) No. 1935/2004.
- This appliance has been designed, manufactured and marketed in compliance with:
 - safety objectives of the “Low Voltage” Directive 2006/95/CE (which replaces 73/23/CEE and subsequent amendments);
 - the protection requirements of Directive “EMC” 2004/108/EC.

Before using the appliance

To ensure best use of your appliance, carefully read the operating instructions which contain a description of the product and useful advice. Keep these instructions for future reference.

1. After unpacking the appliance, make sure it is not damaged and that the door closes properly.

Any damage must be reported to the dealer within 24 hours of delivery of the appliance.

2. Wait at least two hours before switching the appliance on, to ensure that the refrigerant circuit is fully efficient.
3. Clean the inside of the appliance before using it.

Precautions and general recommendations

INSTALLATION

- Be careful not to damage the floors (e.g. parquet) when moving the appliance.
- Make sure the appliance is not near a heat source.
- Install and level the appliance on a floor strong enough to take its weight and in a place suitable for its size and use.
- The appliance is arranged for operation in places where the temperature comes within the following ranges, according to the climatic class given on the rating plate. The appliance may not work properly if it is left for a long time at a temperature outside the specified range.

Climatic Class	Amb. T. (°C)
SN	From 10 to 32
N	From 16 to 32
ST	From 16 to 38
T	From 16 to 43

- Make sure the voltage specified on the rating plate corresponds to that of your home.

SAFE USE

- Do not store or use petrol, flammable liquids or gas in the vicinity of this or other electrical appliances. The fumes can cause fires or explosions.

Energy-saving tips

- Install the appliance in a dry, well ventilated room far away from any heat source (e.g. radiator, cooker, etc.) and in a place not exposed directly to the sun. If required, use an insulating plate.
- To guarantee adequate ventilation follow installation instructions.
- Insufficient ventilation on back of the product increases energy consumption and decreases cooling efficiency.
- The internal temperatures of the appliance may be affected by the ambient temperature, frequency of door opening, as well as location of the appliance. Temperature setting should take into consideration these factors.
- Allow warm food and drinks to cool down before placing in the appliance.
- Do not obstruct the fan (if available) with food items.
- After placing the food check if the door of compartments closes properly, especially the freezer door.
- Reduce to a minimum door opening.
- When thawing frozen food, place them in the refrigerator. The low temperature of the frozen

- Do not swallow the contents (non-toxic) of the ice packs (in some models).
- Do not eat ice cubes or ice lollies immediately after taking them out of the freezer since they may cause cold burns.
- For products designed to use an air filter inside an accessible fan cover, the filter shall be always in position when the refrigerator is in function.
- Before carrying out any maintenance or cleaning operation, unplug the appliance or disconnect it from the power supply.
- Use the refrigerator compartment only for storing fresh food and the freezer compartment only for storing frozen food, freezing fresh food and making ice cubes.
- Do not store glass containers with liquids in the freezer compartment since they may break.
- Avoid storing unwrapped food in direct contact with internal surfaces of the refrigerator or freezer compartments.
- “The bulb used inside the appliance is specifically designed for domestic appliances and is not suitable for general room lighting within the home (EC Regulation 244/2009)”.

The Manufacturer declines any liability for injury to persons or animals or damage to property if the above advice and precautions are not respected.

- products cools the food in the refrigerator.
- Appliances could have special compartments (Fresh Food Compartment, Zero Degree Box,...). In case not differently specified in the specific booklet of product, they can be removed, maintaining equivalent performances.
- Positioning of the shelves in the refrigerator has no impact on the efficient usage of energy. Food should be placed on the shelves in such way to ensure proper air circulation (food should not touch each other and distance between food and rear wall should be kept).
- You can increase storage capacity of frozen food by removing baskets and, if present, Stop Frost shelf, maintaining an equivalent energy consumption.
- Damaged gasket must be replaced as soon as possible.
- High energy class products are fitted with highefficiency motors that remain operational for longer, but have a low power consumption. Do not worry if the engine continues to run for longer periods.

Electrical connection for Great Britain and Ireland only

Warning - this appliance must be earthed

Fuse replacement

If the mains lead of this appliance is fitted with a BS 1363A 13amp fused plug, to change a fuse in this type of plug use an A.S.T.A. approved fuse to BS 1362 type and proceed as follows:

1. Remove the fuse cover (A) and fuse (B).
2. Fit replacement 13A fuse into fuse cover.
3. Refit both into plug.

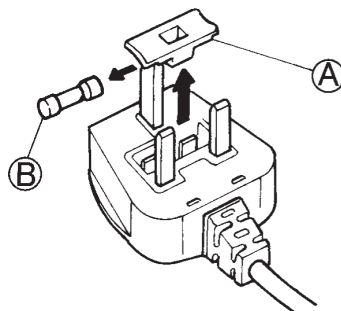

Important:

The fuse cover must be refitted when changing a fuse and if the fuse cover is lost the plug must not be used until a correct replacement is fitted.

Correct replacement are identified by the colour insert or the colour embossed in words on the base of the plug.

Replacement fuse covers are available from your local electrical store.

For the Republic of Ireland only

The information given in respect of Great Britain will frequently apply, but a third type of plug and socket is also used, the 2-pin, side earth type.

Socket outlet / plug (valid for both countries)

If the fitted plug is not suitable for your socket outlet, please contact After-sales Service for further instruction. Please do not attempt to change plug yourself. This procedure needs to be carried out by a qualified technician in compliance with the manufactures instructions and current standard safety regulations.

Using for the first time

Connect the appliance to the power supply.

In models with electronics, a sound signal may be emitted, which means that the temperature alarm has been activated: press the sound alarm off button. Where provided, position the antibacterial anti-odour filter in the fan as demonstrated in the filter packaging.

Note: After turning the appliance on, you must wait for 4-5 hours for the correct storage temperature to be reached for a normally filled appliance.

Maintenance and cleaning of the appliance

Clean the appliance occasionally with a cloth and a solution of warm water and neutral cleaning agents specifically for cleaning the inside of the refrigerator. Do not use abrasive cleaning agents. To ensure the constant and correct flow of the defrosting water, regularly clean the inside of the drain situated in the back wall of the refrigerator compartment near the fruit and vegetable drawer using the utensil provided (see figure).

Before carrying out any maintenance or cleaning, take the plug out of the socket or disconnect the appliance from the power supply.

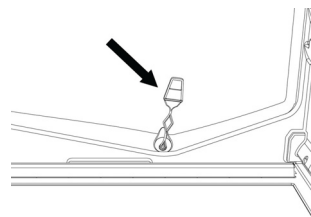

Replacing the light bulb or LED (depending on the model)

Always disconnect the appliance from the power supply before replacing the light bulb. Then follow the instructions based on the type of light bulb for your product.

Replace the light bulb with one with the same features, available from the Technical Assistance Service and authorised sellers.

Light type 1)

To remove the light bulb, unscrew it in an anti-clockwise direction, as shown in the figure. Wait 5 minutes before reconnecting the appliance.



- traditional light bulb (max 25W)

or

- LED light bulb (with the same features)
only available from the Technical Assistance Service



Light bulb



LED light bulb

Light type 2)

If the product has LED lights, as demonstrated in the figures below, contact the Technical Assistance Service if you need a replacement. LEDs last longer than traditional light bulbs, improve internal visibility and are environmentally-friendly.

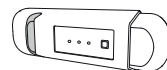
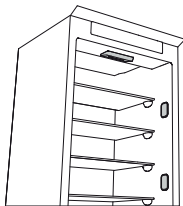

In the event of non-use of the appliance

Disconnect the appliance from the power supply, empty it, defrost it (if necessary) and clean it. Keep the doors slightly ajar to let air circulate inside the compartments. By doing this, you avoid the development of mould and bad odours.

In the event of an interruption to the power supply

Keep the doors closed so the food stays cold for as long as possible. Do not re-freeze food that has partially defrosted. If there is a prolonged power cut, the black out alarm may also activate (in products with electronics).

Refrigerator compartment

The refrigerator compartment allows for the storage of fresh food and drink.

The refrigerator compartment defrosts completely automatically.

The occasional presence of drops of water on the internal back wall of the compartment is a sign of the automatic defrosting phase. The defrosting water is channelled into a drain and then collected in a container, where it evaporates.

Refrigerator compartment

Depending on the model, the product may be equipped with a special “Zero Degrees” compartment, which is ideal for storing fresh meat and fish.

Warning: do not clean refrigerator accessories in a dishwasher.

Note: the ambient temperature, how often the doors are opened and the position of the appliance may affect the internal temperatures in the two compartments. Set the temperatures depending on these factors.

Note: in very humid conditions, condensation may form in the refrigerator compartment, especially on the glass shelves. In this case, it is recommended that you close containers with liquids in (e.g. a pot of stock), wrap up food with a high water content (e.g. vegetables) and turn on the fan, if there is one.

Removing the fruit and vegetable drawer (depending on the model)

Pull the drawer outwards as far as it will go, lift it up and take it out.

To make it easier to remove the fruit and vegetable drawer, it may be necessary to empty (and possibly remove) the two lower door shelves and then continue to remove the drawer.

Fan and antibacterial anti-odour filter (depending on the model)

The fan allows for the even distribution of the temperatures inside the compartments and, consequently, better preservation of the food and reduction of excess humidity. Do not obstruct the ventilation area. The fan can be turned on/off manually (see the Quick Guide); if it is turned on, it operates automatically when necessary.

Freezer compartment

Model with separate freezer compartment

The freezer compartment *** **** allows for the storage of frozen food (for the period indicated on the packaging) and the freezing of fresh food. The quantity of fresh food that can be frozen in 24 hours is written on the rating plate. Arrange the fresh food in the freezing area inside the freezer compartment (see Quick Guide), leaving enough space around the food packages to allow air to circulate freely. It is advisable that you do not re-freeze food that has partially defrosted. It is important to wrap the food in a way that prevents the ingress of water, humidity or condensation.

Making ice cubes

Fill 2/3 of the ice tray (if available) with water and put it back in the freezer compartment. Do not use sharp or pointed objects to remove the ice under any circumstances.

Removing the drawers (depending on the model)

Pull the drawers outwards as far as they will go, lift them up and remove them. To get more volume, the freezer compartment can be used without the drawers.

Make sure that the door is closed properly after putting the food back on the grilles/shelves.



figure 1

Models with an internal product compartment

In the freezer compartment *** **** you can also freeze fresh food. The quantity of fresh food that can be frozen in 24 hours is written on the rating plate.

How to freeze fresh food:

- arrange the food on the grille, if present (figure 1), or directly on the bottom of the compartment (figure 2)
- put the food in the middle of the *** **** compartment without it coming into contact with food that is already frozen, keeping a distance of about 20 mm (figure 1 and 2).

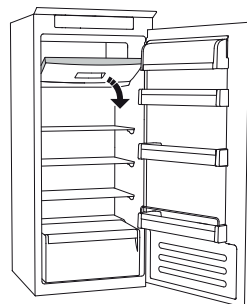

figure 2

How to defrost the freezer compartment (depending on the model)

For frost free models it is not necessary to carry out any defrosting procedures.

For other models, the build up of frost is a normal occurrence.

The quantity and speed of frost accumulation varies depending on the ambient conditions and how often the door is opened. It is advisable to set the temperature colder or, if available, turn on the quick freeze function (see Quick Guide) four hours before removing the food from the freezer compartment, to prolong the preservation of the food during the defrosting phase. To defrost, turn the appliance off and remove the drawers. Put the frozen food in a cool place. Leave the door open to allow the frost to melt. To prevent the water from escaping during the defrost, it is advised that you place an absorbent cloth on the bottom of the freezer compartment and wring it out regularly.

Clean the inside of the freezer compartment and dry it carefully.

Turn the appliance back on and put the food back inside.

STOP FROST SYSTEM (depending on the model)

The **STOP FROST SYSTEM** (available depending on the model) facilitates the defrost procedure for the freezer compartment. The **STOP FROST accessory** (figure 1) is designed to collect some of the frost that forms in the freezer compartment and it is easy to remove and clean, therefore reducing the time needed to defrost the inside of the freezer compartment.

To remove the frost on the **STOP FROST accessory** follow the cleaning procedure demonstrated below.

Procedure to clean the STOP FROST accessory

- Open the freezer compartment door and remove the upper drawer (figure 2).
- Unfasten the **STOP FROST accessory** (figure 3) and remove it (figure 4), taking care not to drop it on the glass shelf below.

Note: if the accessory is jammed or difficult to remove, do not keep trying to remove it, but proceed with the complete defrost of the freezer compartment.

- Close the door to the freezer compartment.
- Remove the frost on the accessory by rinsing it under running (not hot) water (figure 5).
- Let the accessory drip dry and dry the plastic parts with a soft cloth.
- Reinsert the accessory by placing the back part on the projections shown in figure 7-A, then refasten the handle of the accessory to the clasps above (figure 7-B).
- Reinsert the upper drawer and close the door to the freezer compartment.

It is possible to clean the **STOP FROST accessory** on its own without completely defrosting the freezer compartment. Cleaning the **STOP FROST accessory** regularly helps to reduce the need to completely defrost the freezer compartment.

Note: the product specifications, including volume and energy, are calculated without the **STOP FROST accessory**.

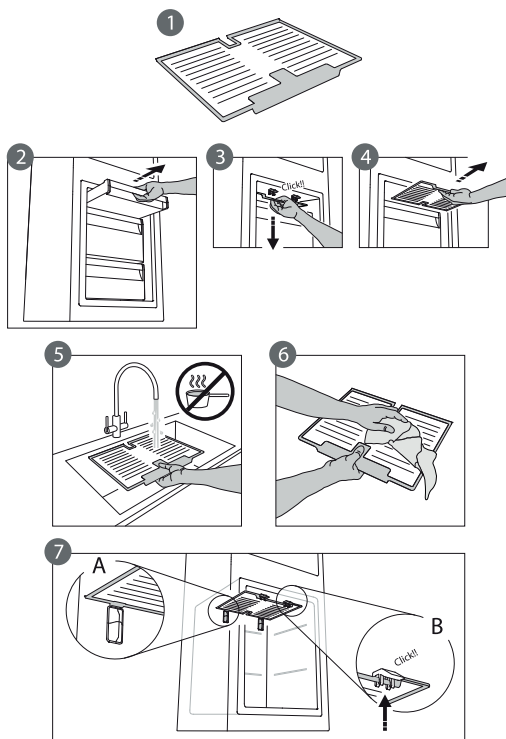

“Zero Degrees” compartment (depending on the model)

The “Zero Degrees” compartment is specifically designed to maintain a low temperature and the correct humidity to preserve fresh food for longer (for example, meat, fish, fruits and winter vegetables).

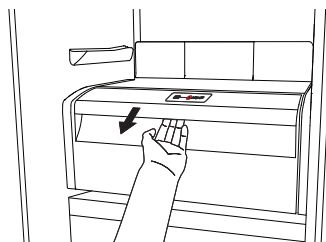

Turning on and turning off the compartment

The internal temperature of the compartment is approximately 0° when the compartment is turned on.

To turn on the compartment, press the button shown in the figure for more than one second until the symbol lights up.



The lit symbol means that the compartment is working. Press the button again for more than one second to turn off the compartment.

To turn off the compartment completely, you must remove the drawer.

For the correct functioning of the “Zero Degrees” compartment, it is necessary that:

- the refrigerator compartment is turned on
- the temperature is between +2°C and +6°C
- the drawer in the “Zero Degrees” compartment must be inserted for it to be turned on
- one of the following special functions is not selected: Stand-by, Cooling-Off, Vacation (if present), in this case, remove the food contained in it.

Note:

- if the symbol does not light up when you turn on the compartment, check that the drawer is properly inserted; if the problem persists contact the authorised Technical Assistance Service.
- if the compartment is turned on and the drawer is open, the symbol in the control panel may automatically turn off. The symbol will light up again when the drawer is inserted
- regardless of the state of the compartment, you may hear a faint noise, which you should consider as normal
- when the compartment is not in operation, the temperature inside it depends on the general temperature of the refrigerator compartment. In this case, it is advised that fruits and vegetables that are not sensitive to cold (berries, apples, apricots, carrots, spinach, lettuce, etc.) are stored in it.

Important: if the compartment is turned on and food with a high water content is present, condensation may form on the shelves. In this case, turn the function off temporarily.

Be careful when positioning food and containers that are small in size on the upper shelf of the “Zero Degrees” compartment in order to prevent them accidentally falling between the shelf and the back wall of the refrigerator compartment.

Removing the “Zero Degrees” compartment:

Carry out the following steps:

- to make it easier to remove the compartment, we recommend that you empty (and possibly remove) the lower door shelves
- turn off the compartment
- remove the compartment by rotating it upwards
- remove the white plastic shelf under the compartment.

Note: it is not possible to remove the upper shelf and side supports.

To use the “**Zero Degrees**” compartment again, carefully reposition the white plastic shelf under the compartment before inserting the drawer and turning the function back on.

To have a larger refrigerator volume and to reduce energy consumption, it is recommended that you turn off the “**Zero Degrees**” compartment and remove the compartment.

Clean the compartment and its components occasionally using a cloth and a solution of warm water (taking care not to submerge the white plastic shelf under the drawer) and neutral cleaning agents specifically for cleaning the inside of the refrigerator. Do not use abrasive cleaning agents.

Before cleaning the compartment (also externally) it is necessary to remove the drawer to disconnect the electrical supply for the compartment.

Use of wooden accessories (if present)

Haute cuisine*

*with selected models only

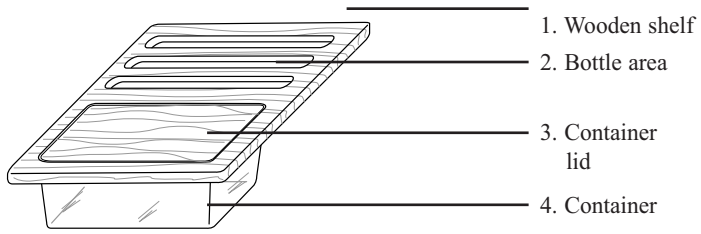

Haute cuisine can be used in 2 different positions

With the container below

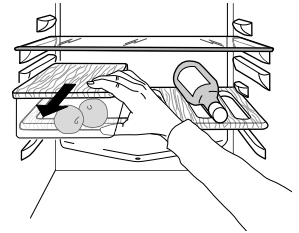
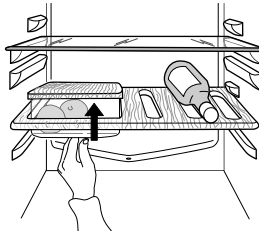
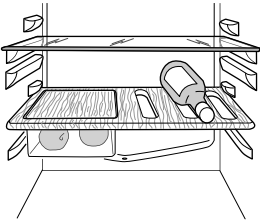
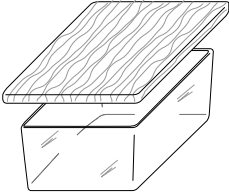

With the container on top, using the lid as a base

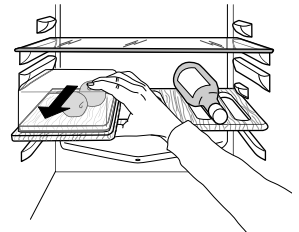
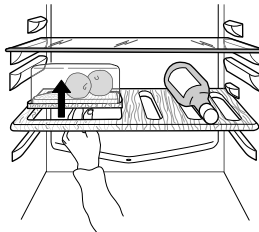
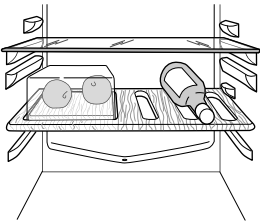
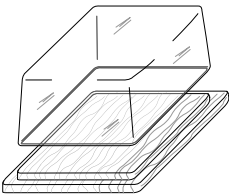

Cheese box*

Both Haute cuisine and Cheese box can be used for serving food at the table. Do not use them in the freezer, microwave oven or on other heat sources.

Do not chop food directly on the wooden surface as it may become scored.

Tips for cleaning:

Do not wash the wooden or plastic components in the dishwasher; we recommend washing them by hand with mild detergent, without the use of abrasive sponges.

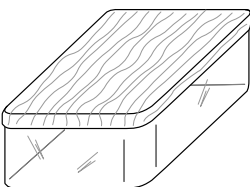

Technical Assistance Service

Before contacting the Technical Assistance Service:

Restart the appliance to check if the problem has been solved. If not, disconnect the appliance again and repeat the procedure after one hour.

If, after having completed the checks listed in the guide for malfunctions and after restarting the appliance, your appliance continues to function incorrectly, contact the Technical Assistance Service, clearly describing the problem and stating:

- the type of malfunction
- the model
- the type and serial number of the appliance
(written on the rating plate)
- the Service number (the number that is after the word SERVICE on the rating plate placed inside the appliance).

SERVICE 0000 000 00000



Note:

Reversing the doors of the appliance, if carried out by the Technical Assistance Service, is not considered as a warranty claim.



FOR THE WAY IT'S MADE.

Printed in Italy
/// 03/15

400010780180

